



melogranoblu

HYDRA SYSTEM

LEGEND



CLEAR GLASS



FROSTED GLASS



RULED CLEAR GLASS



RULED FROSTED GLASS



METALLIZED



INNER LIGHT



REFLECTED LIGHT



SUSPENSION LAMP

INDEX

HYDRA SYSTEM	69
COMPONENTS	83
GLASSES	84
ACORN	86
ALPHA	88
ACQUA	XX
AVATAR	88
BERRY	90
BERRY METAL	92
BETA	96
DATURA	98
DELTA	100
DERVISCI	XXX
DIESIS	104
GAMMA	106
JANUS	108
LAMBDA	112
LHASA	114
OMEGA	116
ONION	120
ORGANIC	122
SIGMA	124
STIGMA	128
THETA	130
VITAMINE	132
VITAMINE METAL	134
LED CEILING LIGHTS	136
INNER LIGHTS	139
TUBE	140

THE FACTORY OF EMOTIONS

CONCEIVED AND FOUNDED IN 1997 BY ERMANNOCCHI AND MASSIMO CREMA, MELOGRANOBLU IS AN ITALIAN INTERIOR LIGHTING COMPANY. OVER THE YEARS, THE COMPANY HAS DEVELOPED A WIDE RANGE OF SOLUTIONS FOR INTERIOR LIGHTING DESIGN, SUITABLE FOR HOMES OR OFFERING MORE IMPRESSIVE INSTALLATIONS FOR LARGE ARCHITECTURAL SETTINGS.

MELOGRANOBLU CREATIONS ARE VERITABLE SPECTACLES OF LIGHT, FOCUSING ON THE SENSORY AND EMOTIONAL EFFECT OF LIGHT THROUGH GLASS.

DESIGN PROJECTS IN WHICH ALL FORMS OF GLASS ARE CONCEIVED AND DESIGNED ACCORDING TO THE EFFECTS THEY CAN GENERATE THROUGH LIGHT.

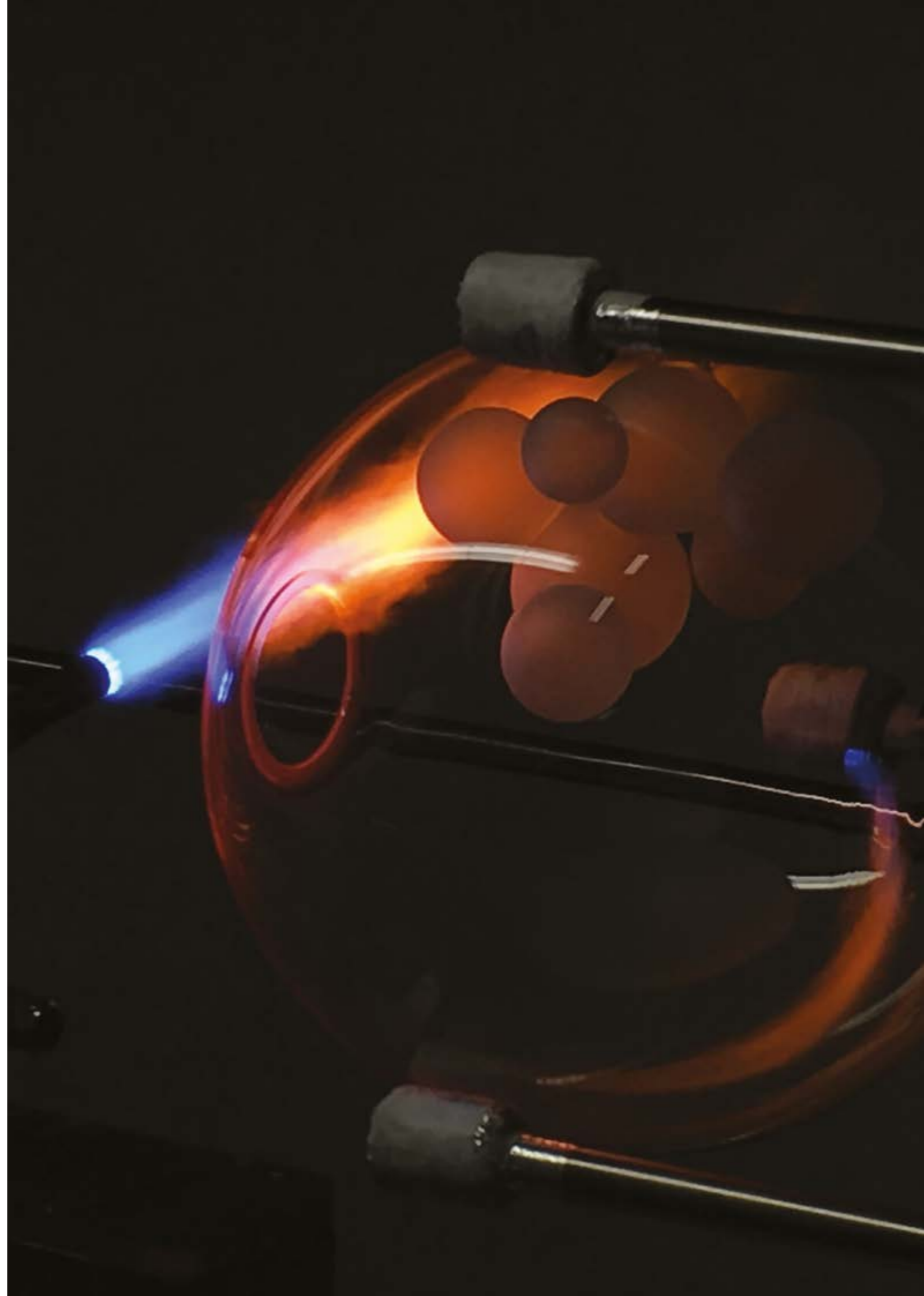

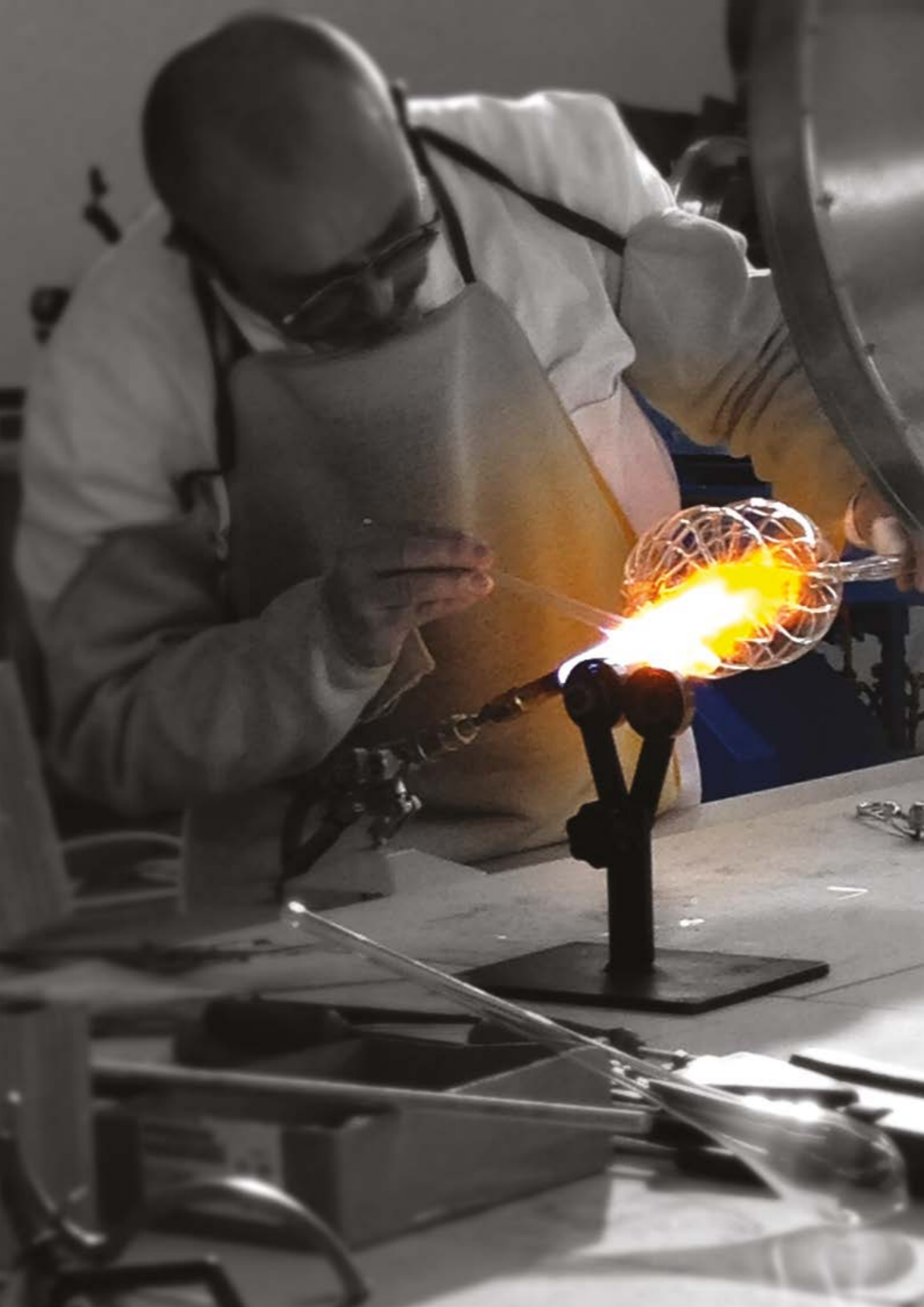

CRAFTED PRODUCTION AND INDUSTRIAL ORGANISATION

ALL MELOGRANOBLU DESIGNS ARE CONCEIVED, DEVELOPED, ENGINEERED AND PRODUCED IN THE COMPANY. A STRUCTURE ORGANISED TO MANAGE AND GUARANTEE "MADE IN ITALY" QUALITY THROUGHOUT THE ENTIRE PRODUCTION PROCESS.

UNIQUE PIECES, THE SAME YET DIFFERENT SINCE THEY ARE MADE WITH PASSION BY SKILLED HANDS THAT CREATE ARTWORKS FROM GLASS.

MADE-TO-ORDER

MELOGRANOBLU'S IN-HOUSE GROUP OF DESIGNERS WORKS IN COLLABORATION WITH THE CLIENT, DEVELOPING EACH SPECIFIC DESIGN IDEA TO ACHIEVE A MADE-TO-MEASURE LIGHT INSTALLATION.

MELOGRANOBLU MADE-TO-ORDER DESIGNS, ALL DEVELOPED AND ENGINEERED WITHIN THE COMPANY, ARE DELIVERED TO THE CLIENT COMPLETE WITH DETAILED INSTRUCTIONS TO GUIDE EASY INSTALLATION IN TOTAL SAFETY.



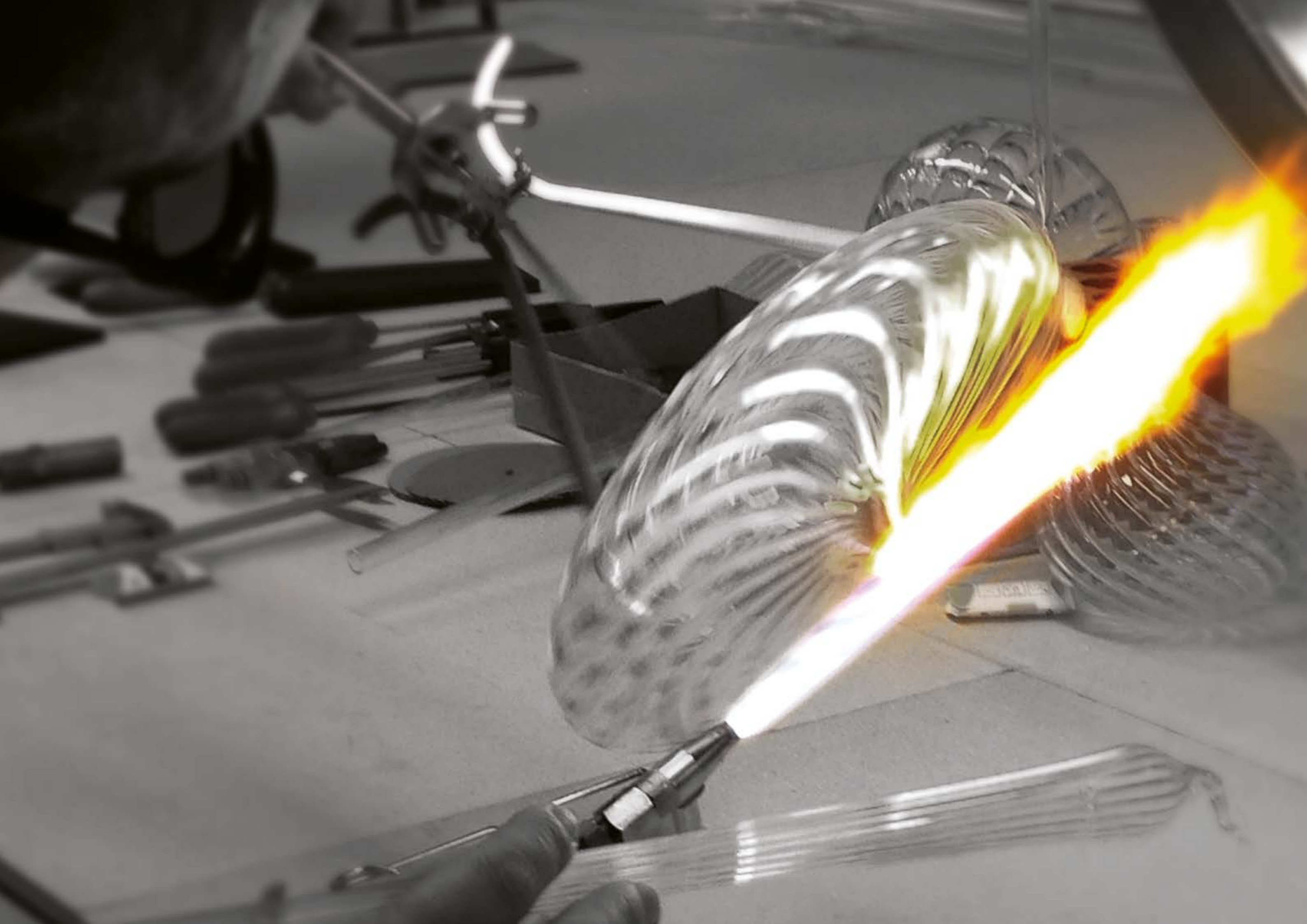



HYDRA SYSTEM

HYDRA IS A MODULAR LIGHTING SYSTEM FOR INTERIORS CREATED BY MELOGRANOBLU FOR DESIGNING AND CREATING ALLURING AND SOPHISTICATED LIGHTING COMPOSITIONS WITH GREAT EASE.

SHAPES IN BLOWN GLASS, CLEAR OR FROSTED, SUSPENDED USING COLOURED TUBULAR METAL LINKS, REFLECT THE LIGHT IN THE ROOM TO CREATE EVOCATIVE ATMOSPHERES.

VERSATILITY, LIGHTNESS, EASY INSTALLATION AND FREEDOM OF DESIGN ARE ITS DISTINCTIVE FEATURES.

WITH HYDRA YOU CAN CREATE COUNTLESS LIGHT CONFIGURATIONS SUITED TO ALL ARCHITECTURAL INTERIORS, BE THEY RESIDENTIAL OR CONTRACT.

THE IN-HOUSE GROUP OF DESIGNERS WORKS IN CLOSE SYNERGY WITH THE CLIENT IN CREATING SPECTACULAR COMPOSITIONS STUDIED FOR THE SPECIFIC INTERIOR DESIGN PROJECT. STARTING OUT WITH A CONCEPT, IT DEVELOPS A DETAILED SHOP DRAWING COMPLETE WITH INSTALLATION INSTRUCTIONS.



LIGHT CREATES
EVOCATIVE
ATMOSPHERES







VERSATILITY
AND FREEDOM
OF DESIGN





HYDRA SYSTEM

COMPONENTS

A LIGHT SOURCE
See page 82

B FIXING ACCESSORIES
See page 82

C METALLIC MESH ROPES
See page 83

D GLASSES
See page 84

A LIGHT SOURCE



LED recessed projector 10W24Vdc 2700k cri93 optics 6° circular body ø 85 mm.

Hydra System is also customizable with:

- LED CEILING LIGHT_See page 136
- INNER LIGHT_See page 139

B FIXING ACCESSORIES



CEILING FIXING SUPPORT

FLOOR FIXING SUPPORT

GLASS FIXING METAL PIN

C METALLIC MESH ROPES

- #T11 Red
- #T34 Fuxia
- #T39 Orange
- #T26 Gold
- #T36 Purple
- #T35 Wistaria
- #T12 China Blue
- #T29 Turquoise
- #T08 Titanium
- #T00 Copper
- #T20 Brown
- #T07 Silver
- #T21 Black



COLOURED METALLIC MESH ROPE TO HANG GLASSES.

Colors in this catalogue may lightly vary because of printing. melgranoblu reserve the right to modify products and colors, without notice, in order to make technical improvements.

D GLASSES

- 1 ACORN page 86
- 2 ALPHA page 88
- 3 ACQUA page xx
- 4 AVATAR page xx
- 5 BERRY page 90 | BERRY METAL page 92
- 6 BETA page 96
- 7 DATURA page 98
- 8 DELTA page 100
- 9 DERVISCI page xxx
- 10 DIESIS page 104
- 11 GAMMA page 106
- 12 JANUS page 108
- 13 LAMBDA page 112
- 14 LHASA page 114
- 15 OMEGA page 116
- 16 ONION page 120
- 17 ORGANIC page 122
- 18 SIGMA page 124
- 19 STIGMA page 128
- 20 THETA page 130
- 21 VITAMINE page 132 | VITAMINE METAL page 134

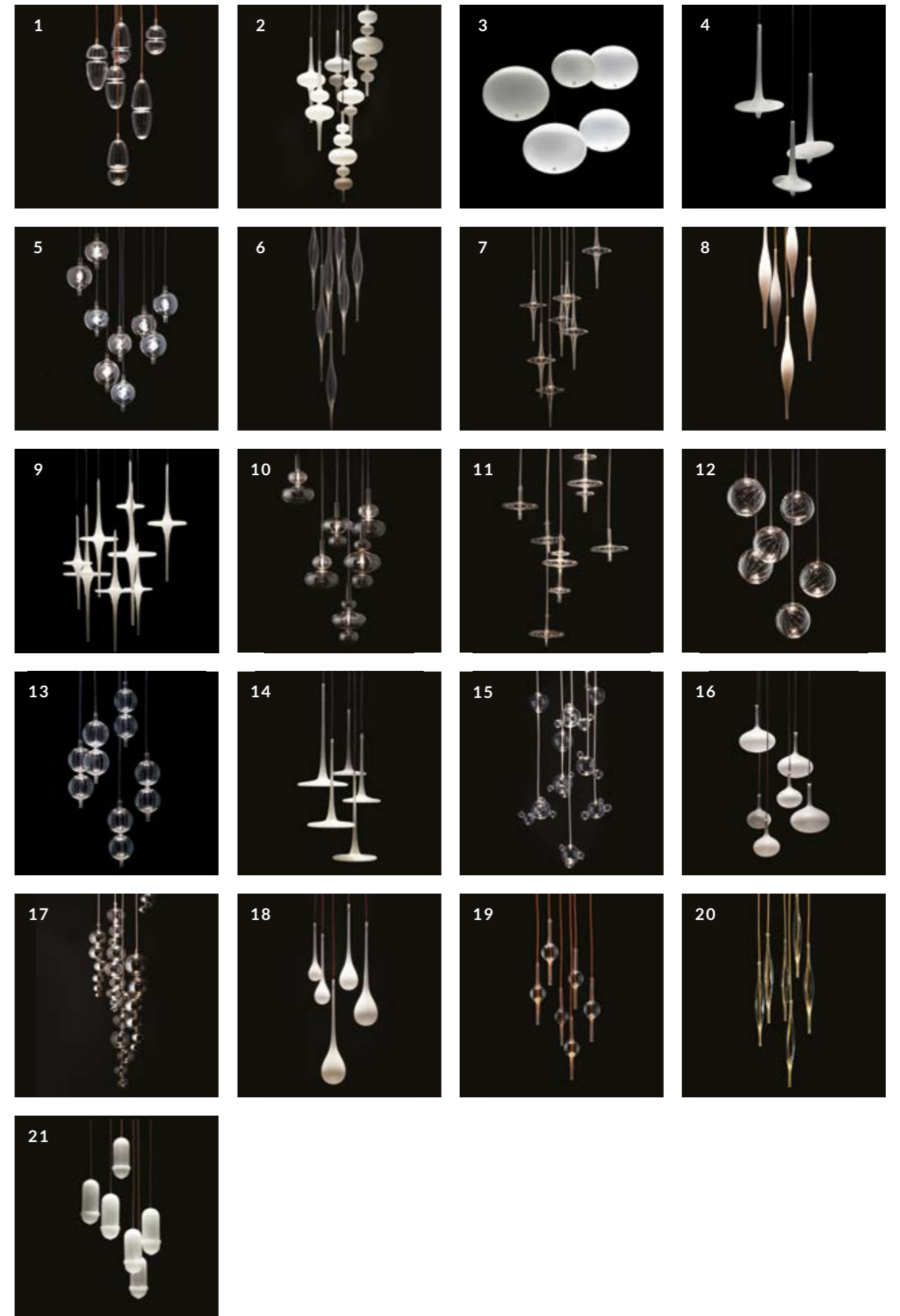

HYDRA

ACORN



CLEAR OR FROSTED HAND-BLOWN RULED GLASS PENDANT.

4 shapes available: ① h. 21,5 - ø 12,5 cm. ② h. 30 - ø 12,5 cm. ③ h. 30 - ø 12,5 cm. ④ h 38,5 - ø 12,5 cm.



HYDRA

ALPHA

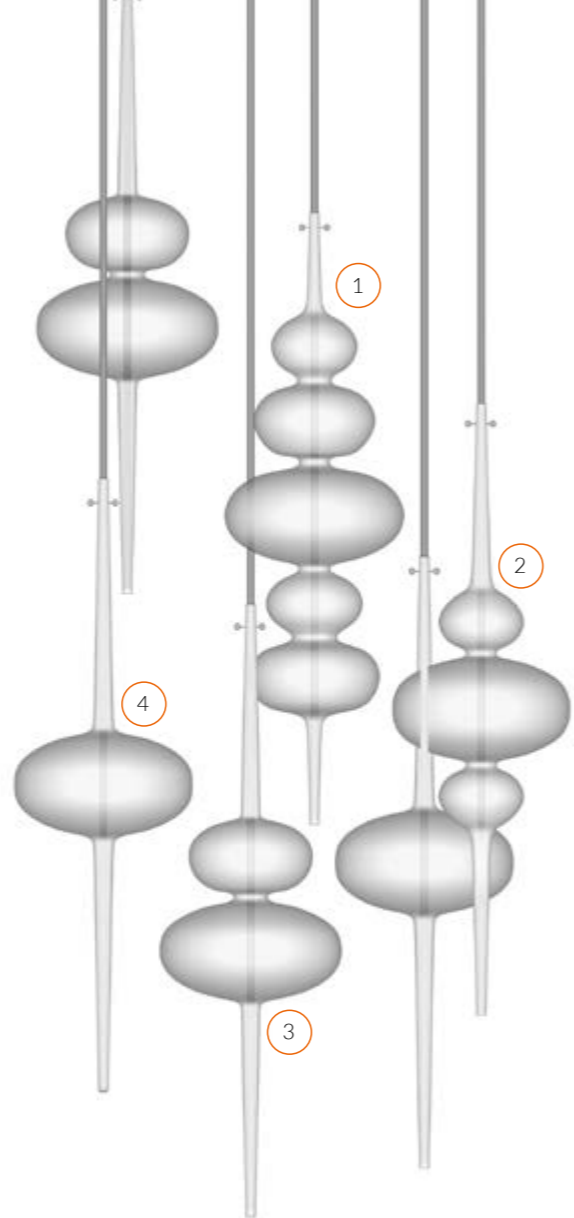

CLEAR OR FROSTED HAND-BLOWN GLASS PENDANT.

4 shapes available: ① h. 45 - ø 15,5 cm. ② h. 45 - ø 15,5 cm. ③ h. 45 - ø 15,5 cm. ④ h 45 - ø 15,5 cm.
Additional inner light can be used with this model (see page 139).



HYDRA

ACQUA

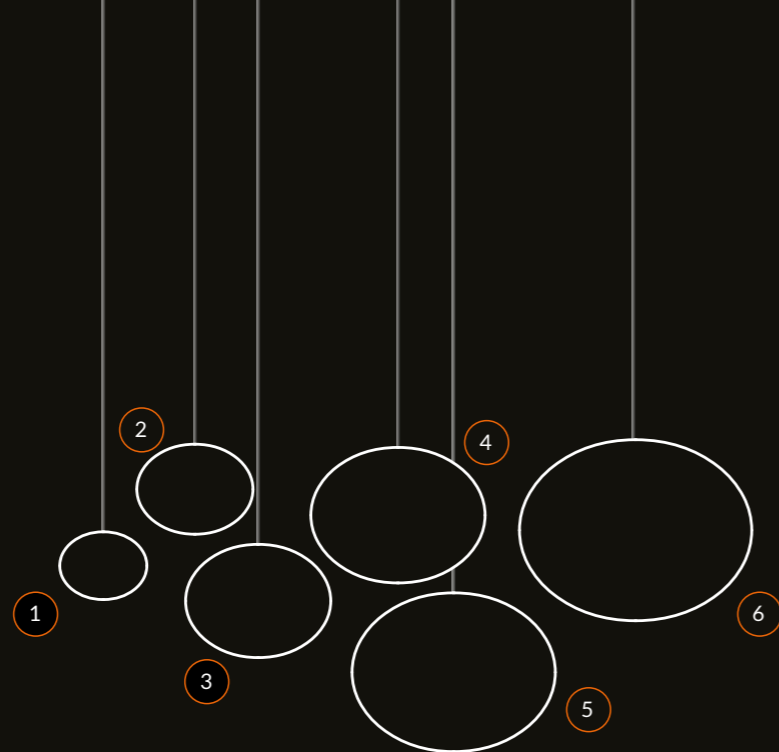

CLEAR OR FROSTED HAND-BLOWN GLASS PENDANT.

6 shapes available: ① ø 9 cm. ② ø 12 cm. ③ ø 15 cm. ④ ø 18 cm. ⑤ ø 21 cm. ⑥ ø 24 cm.

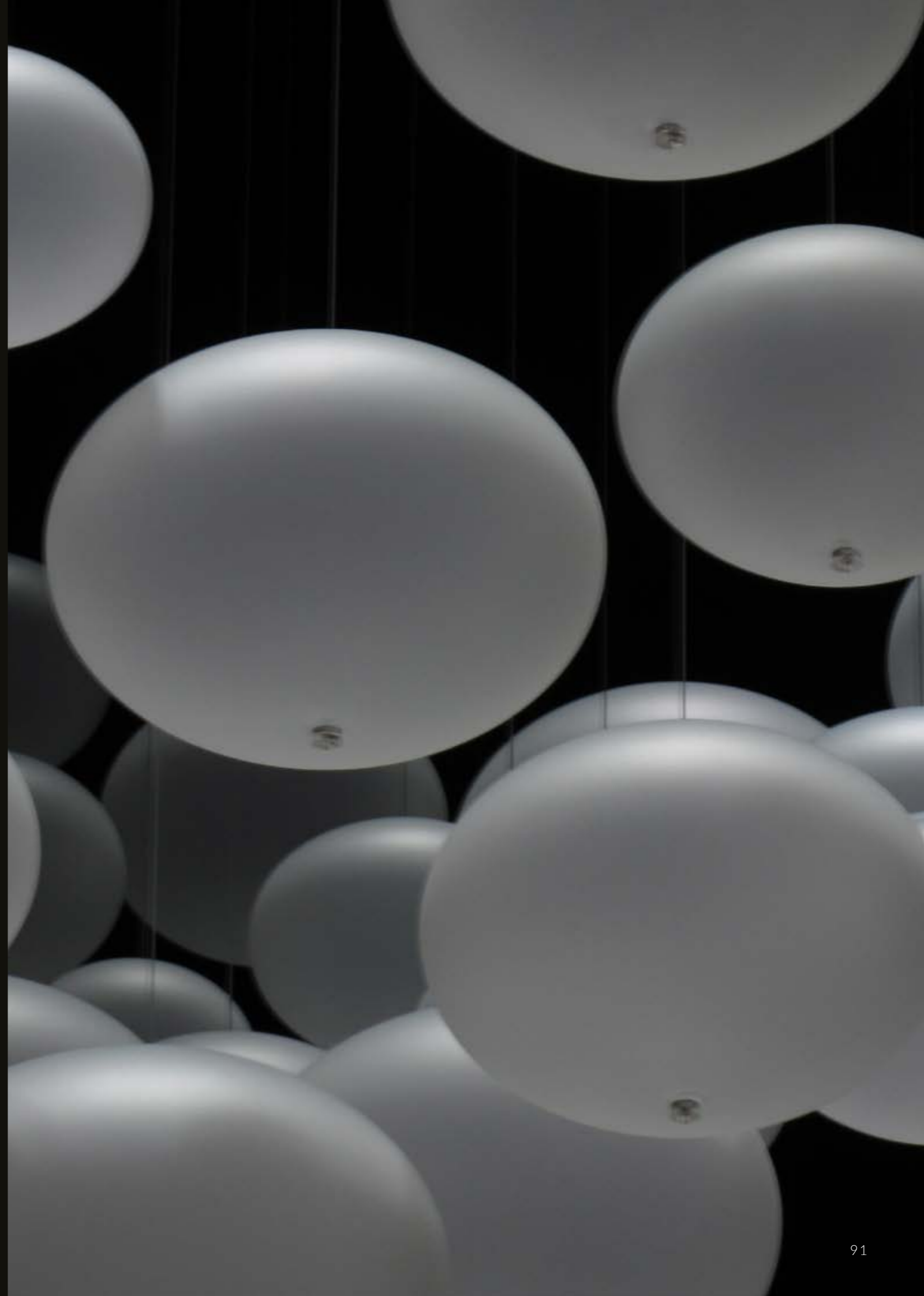

HYDRA

AVATAR

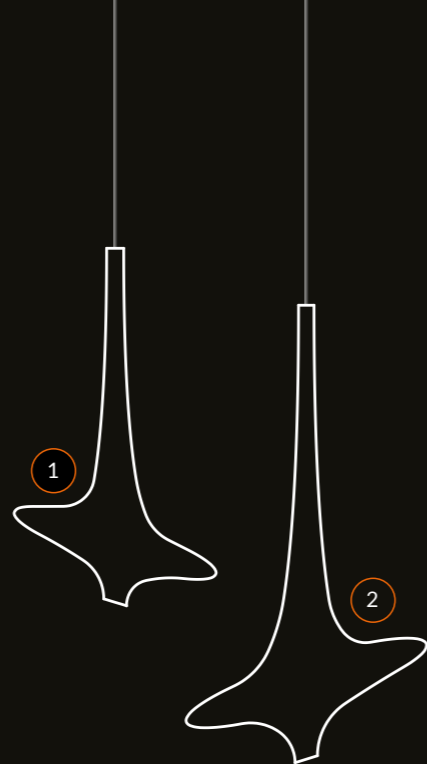

FROSTED OR METALLIZED GOLD HAND-BLOWN GLASS PENDANT.

2 shapes available: ① h. 23 - ø 13 cm. ② h. 29,5 - ø 15,5 cm.



HYDRA

BERRY

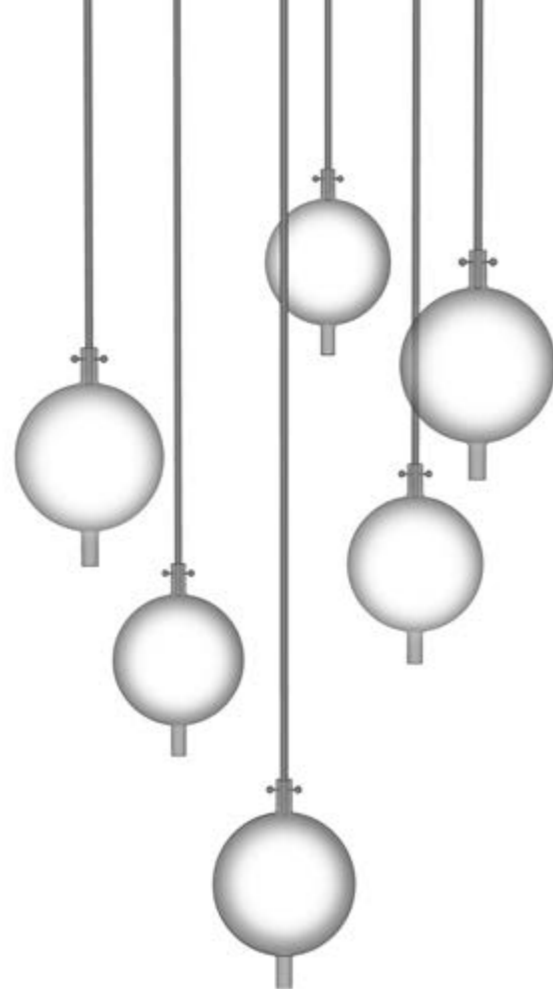

CLEAR HAND-BLOWN GLASS PENDANT.

One size only: h. 24 - ø 16 cm.



HYDRA

BERRY METAL



SILVER OR PINK GOLD METALLIZED HAND-BLOWN GLASS PENDANT.

One size only: h. 24 - ø 16 cm.

Additional inner light can be used with this model (see page 139).



Example of Berry Metal
with inner light.
See page 139.

HYDRA

BETA

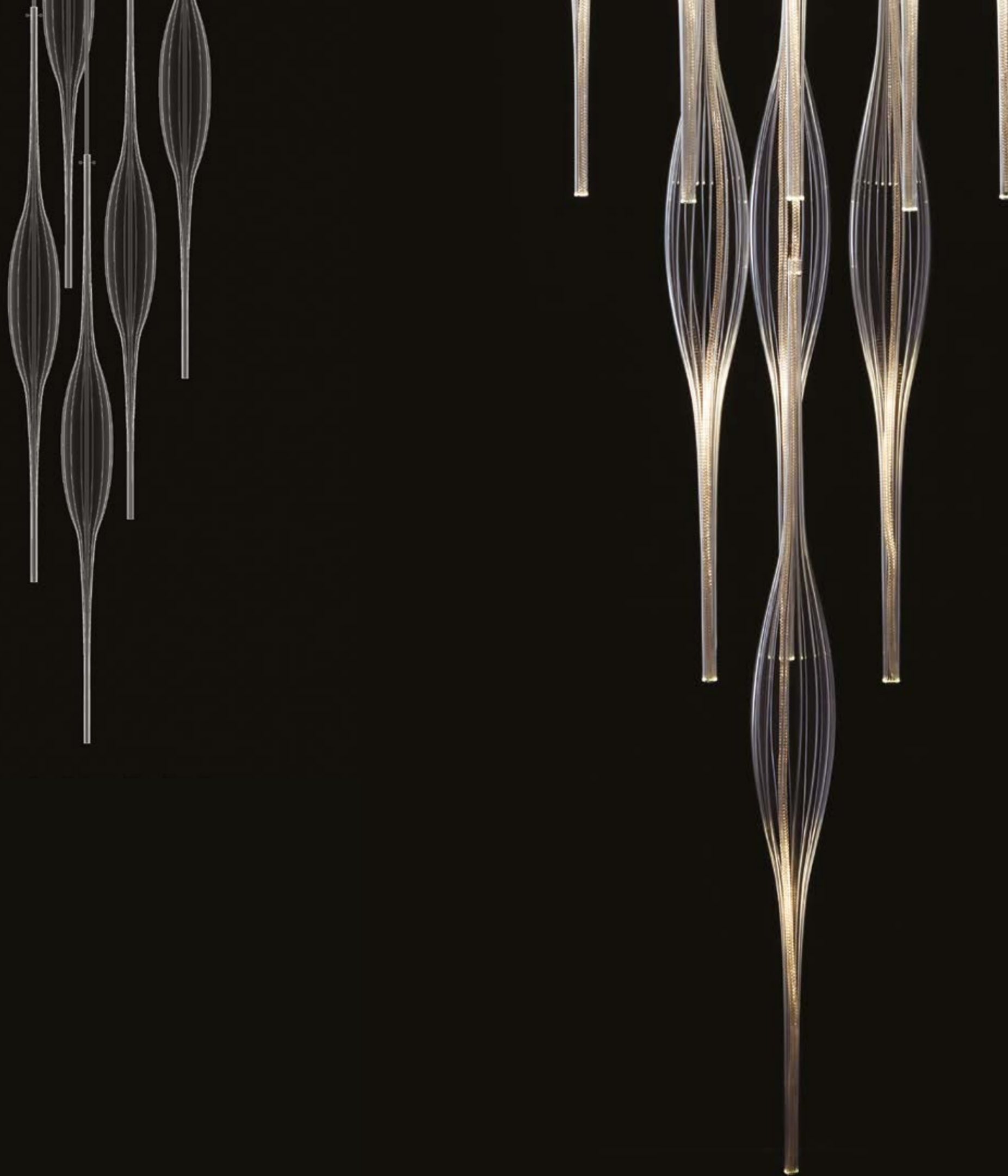

CLEAR OR FROSTED HAND-BLOWN RULED GLASS PENDANT.

One size only: h. 85 - ø 7,5 cm.

Additional inner light can be used with this model (see page 139).



HYDRA

DATURA

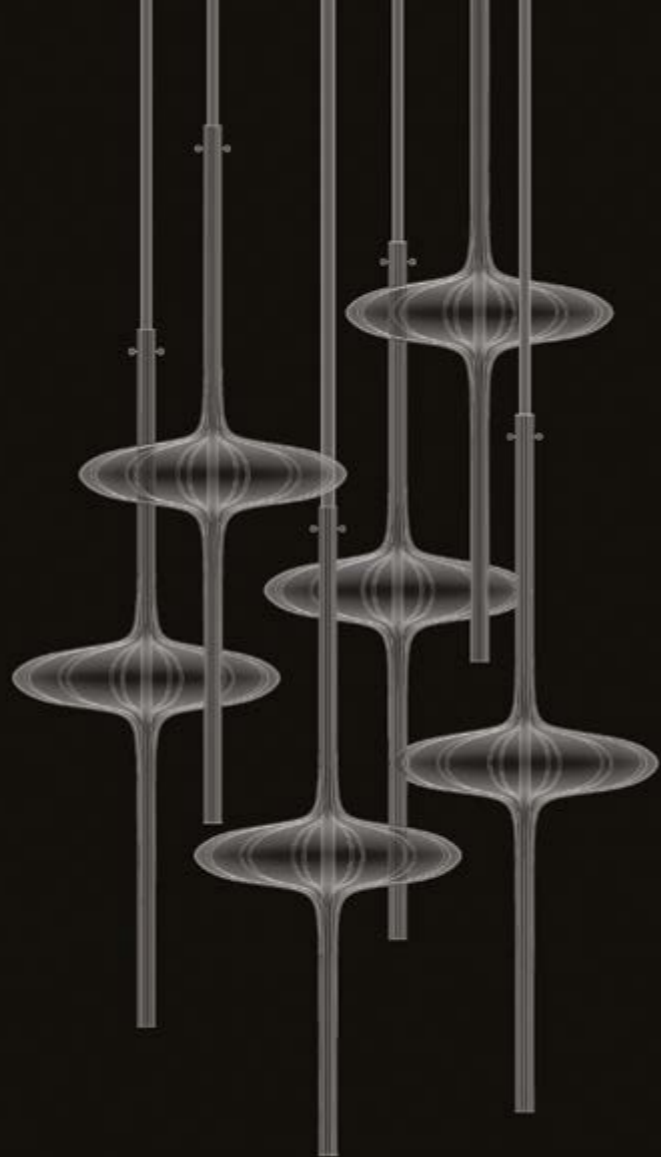

CLEAR OR FROSTED HAND-BLOWN RULED GLASS PENDANT.

One size only: h. 48 - ø 18 cm.

Additional inner light can be used with this model (see page 139).



HYDRA

DELTA

FROSTED HAND-BLOWN GLASS PENDANT.

One size only: h. 50 - ø 6,5 cm.

Additional inner light can be used with this model (see page 139).



HYDRA

DERVISCI

CLEAR OR FROSTED RULED BLOWN GLASS PENDANT.

3 shapes available: ① h. 38,5 - ø 12 cm. ② h. 48,5 - ø 16 cm. ③ h. 58,5 - ø 21 cm.

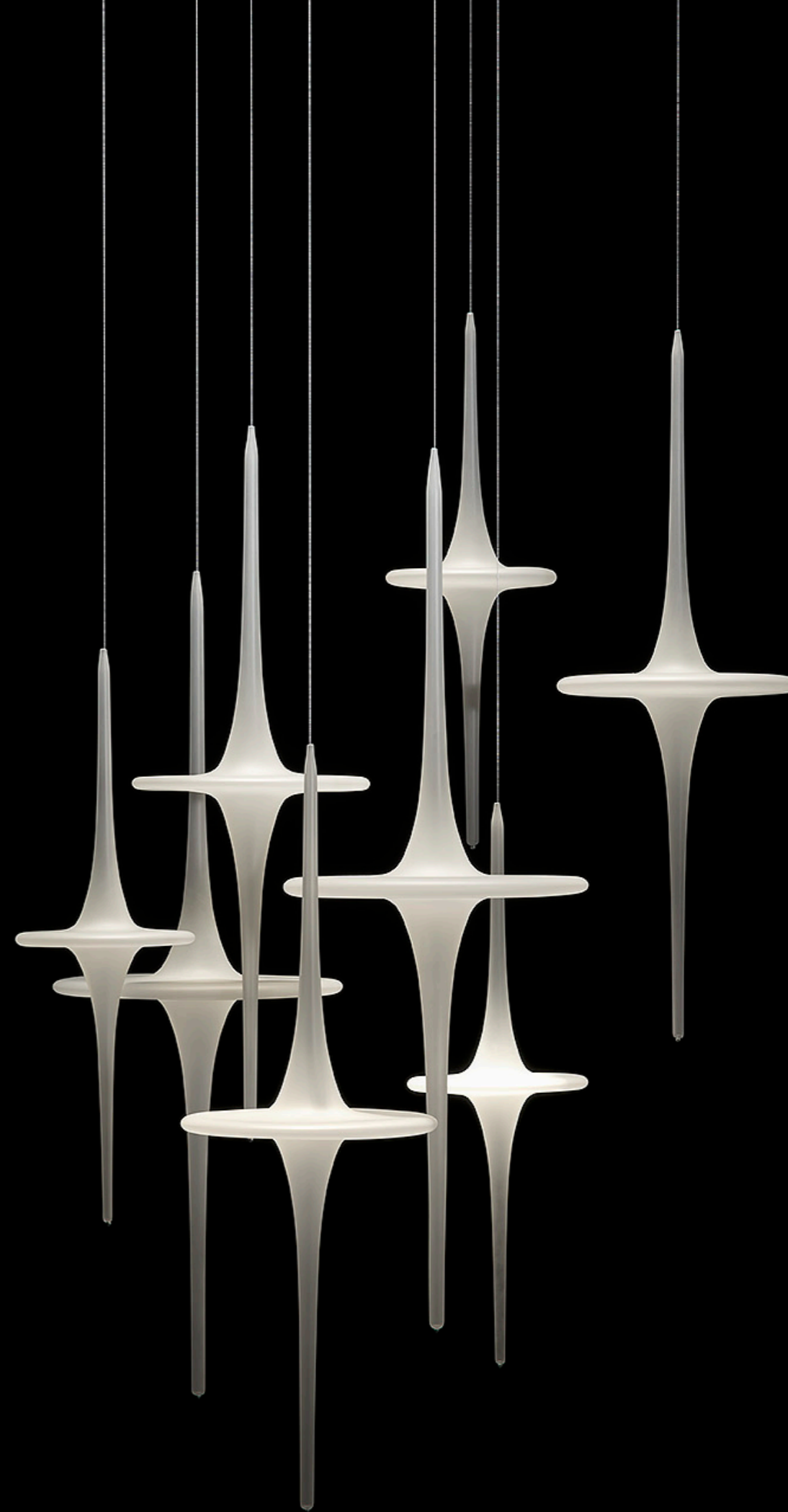

HYDRA

DIESIS



CLEAR, FROSTED OR METALLIZED HAND-BLOWN RULED GLASS PENDANT.

3 shapes available: ① h. 31 - ø 18 cm. ② h. 26 - ø 18 cm. ③ h. 26 - ø 18 cm.
Additional inner light can be used with this model (see page 139).



Example of Diesis
with inner light.
See page 139.

HYDRA

GAMMA

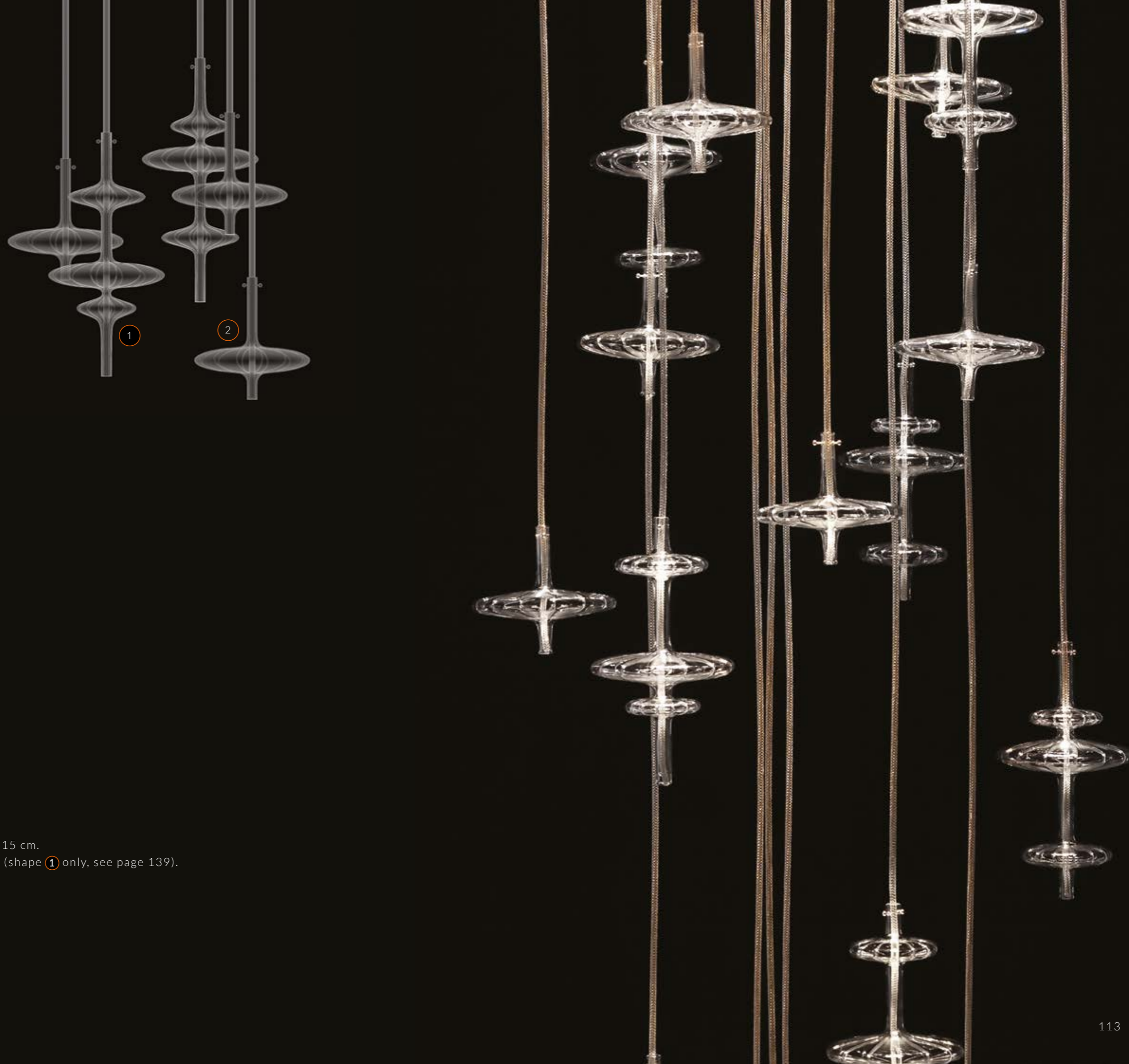

CLEAR HAND-BLOWN RULED GLASS PENDANT.

2 shapes available: ① h. 30 - ø 15 cm. ② h. 17 - ø 15 cm.

Additional inner light can be used with this model (shape ① only, see page 139).



HYDRA

JANUS

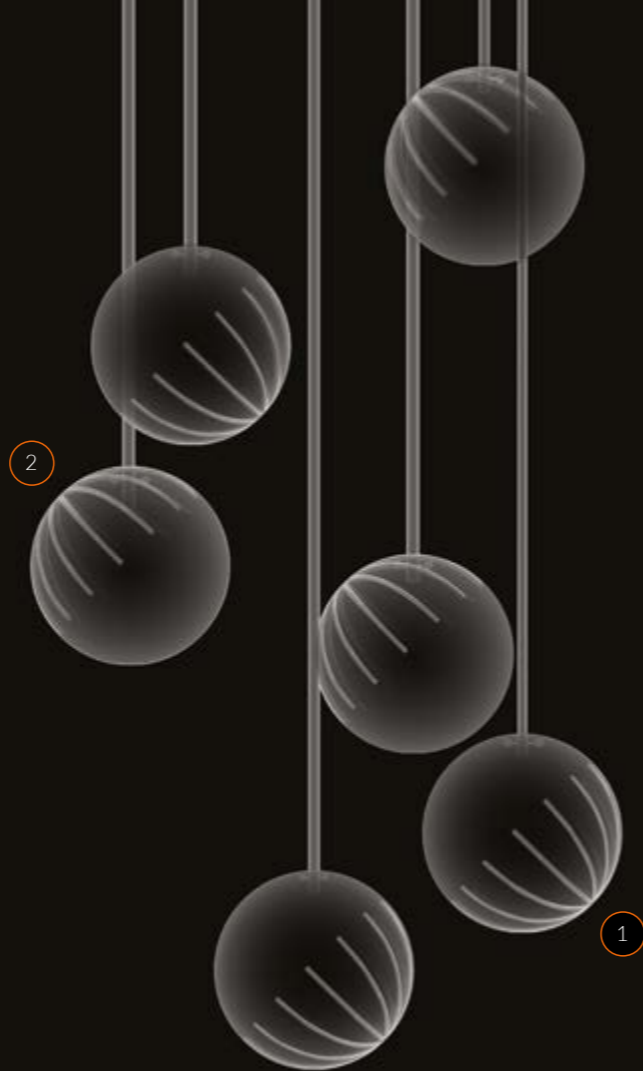

CLEAR OR METALLIZED HAND-BLOWN RULED GLASS PENDANT.

2 shapes available. One size only: ø 16 cm.



HYDRA

LAMBDA

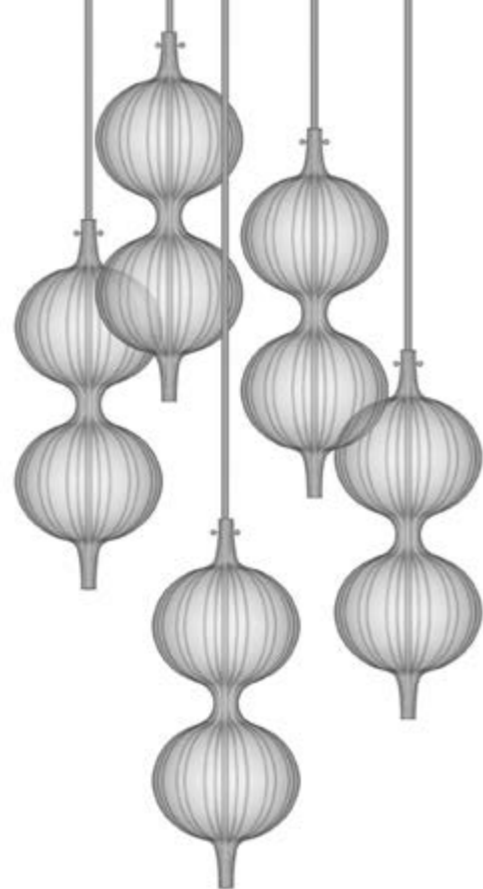

CLEAR OR FROSTED HAND-BLOWN RULED GLASS PENDANT.

One size only: h. 31 - ø 10,5 cm.



HYDRA

LHASA

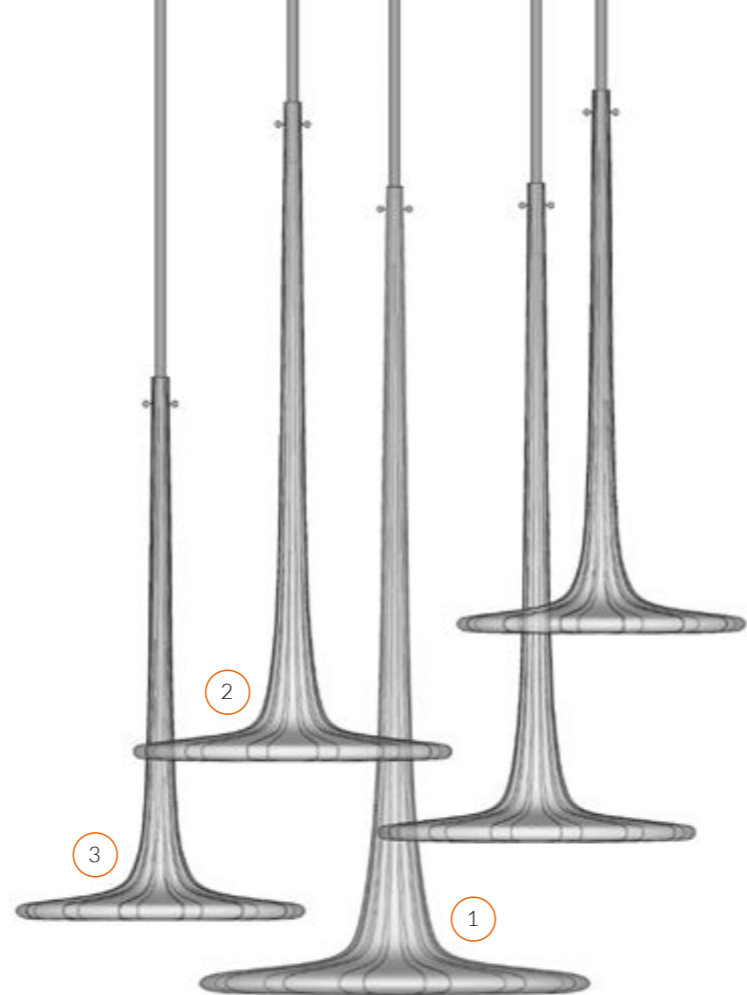

CLEAR OR FROSTED HAND-BLOWN RULED GLASS PENDANT.

3 sizes available: ① h. 56 - ø 27 cm ② h. 45 - ø 22 cm ③ h. 37 - ø 20 cm.



HYDRA

OMEGA

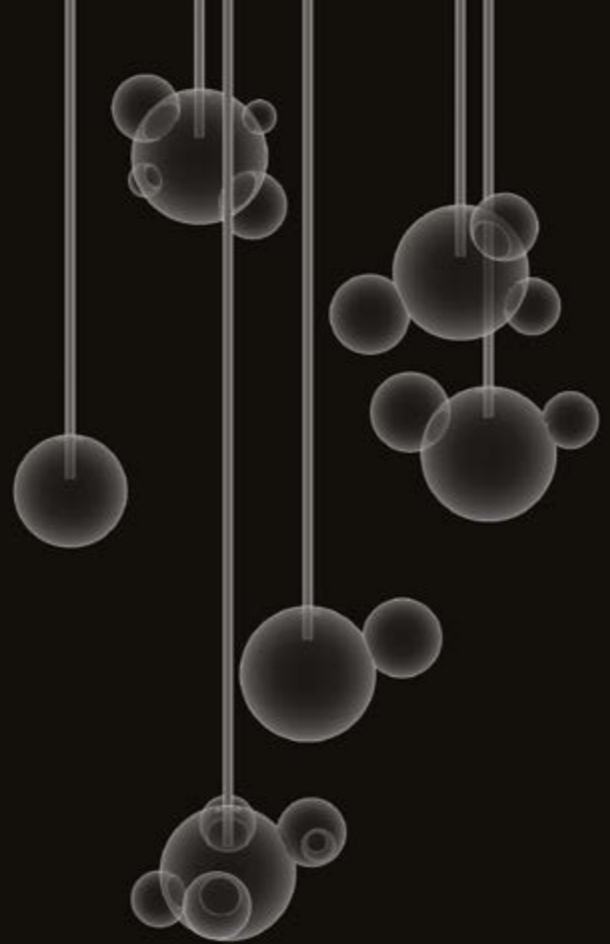

CLEAR HAND-BLOWN GLASS PENDANT.

8 shapes available. From ø 8 up to ø 23 cm.



HYDRA

ONION

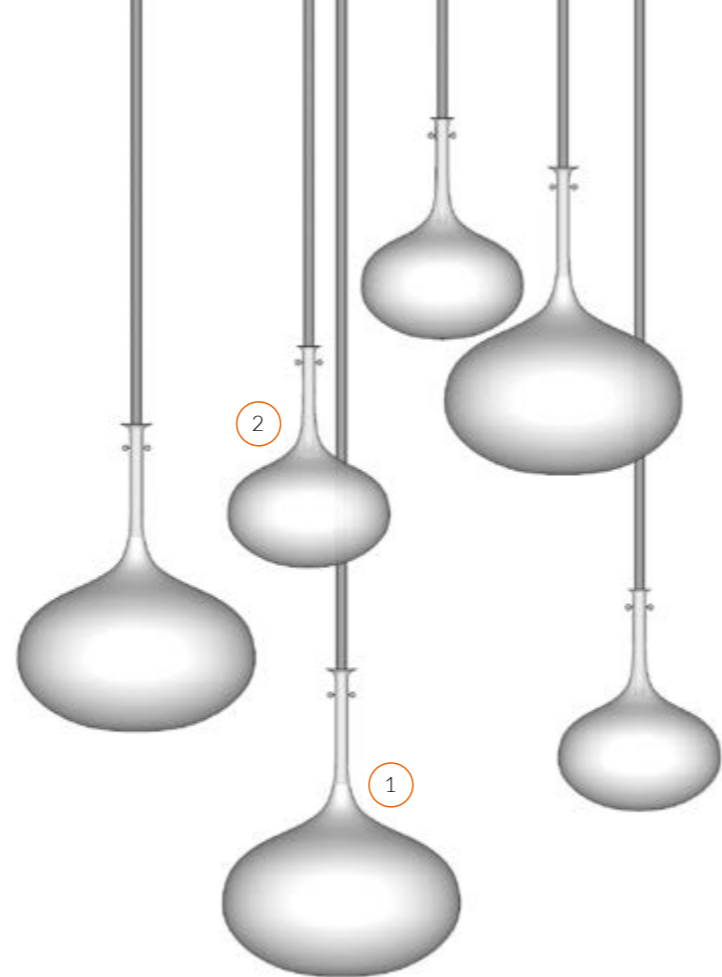

FROSTED HAND-BLOWN GLASS PENDANT.

2 sizes available: ① h. 25 - ø 19 cm. ② h. 18 - ø 13 cm.



HYDRA

ORGANIC



CLEAR OR METALLIZED HAND-BLOWN GLASS PENDANT.

3 shapes available: ① h. 70 - ø 18 cm. ② h. 50 - ø 15 cm. ③ h. 30 - ø 18 cm.



HYDRA

SIGMA

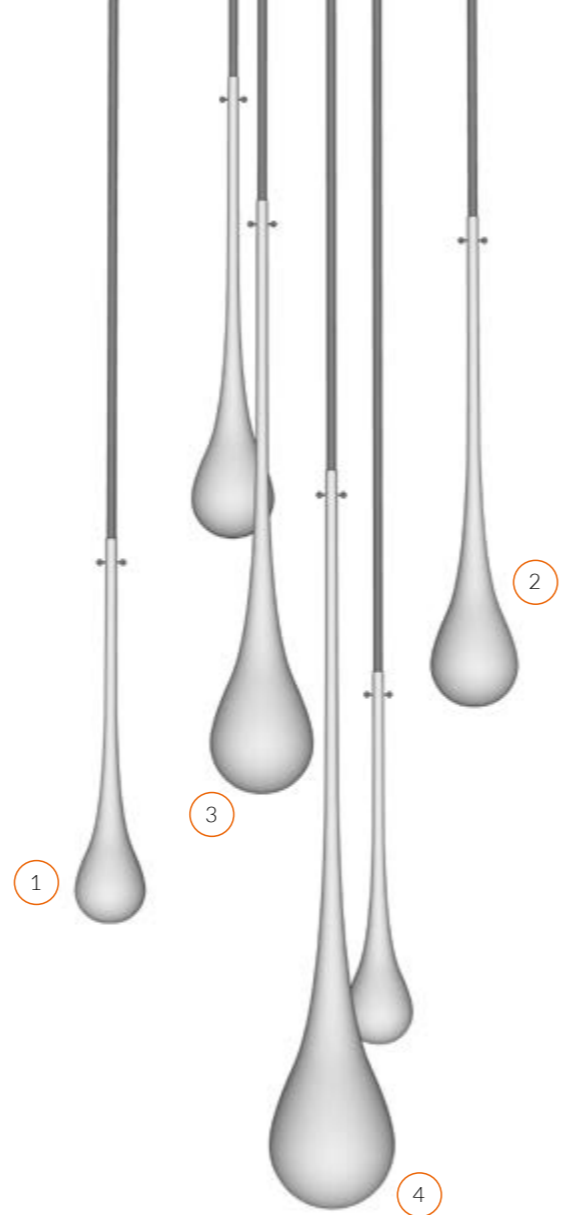

CLEAR OR FROSTED HAND-BLOWN GLASS PENDANT.

4 sizes available: ① h. 35 - ø 7 cm. ② h. 45 - ø 8 cm. ③ h. 55 - ø 9 cm. ④ h. 65 - ø 11 cm.



HYDRA

STIGMA



CLEAR HAND-BLOWN GLASS PENDANT.

One size only: h. 32 - ø 9 cm.

Additional inner light can be used with this model (see page 139).



HYDRA

THETA



CLEAR HAND-BLOWN GLASS PENDANT.

One size only: h. 47 - ø 5,5 cm.

Additional inner light can be used with this model (see page 139).



HYDRA

VITAMINE

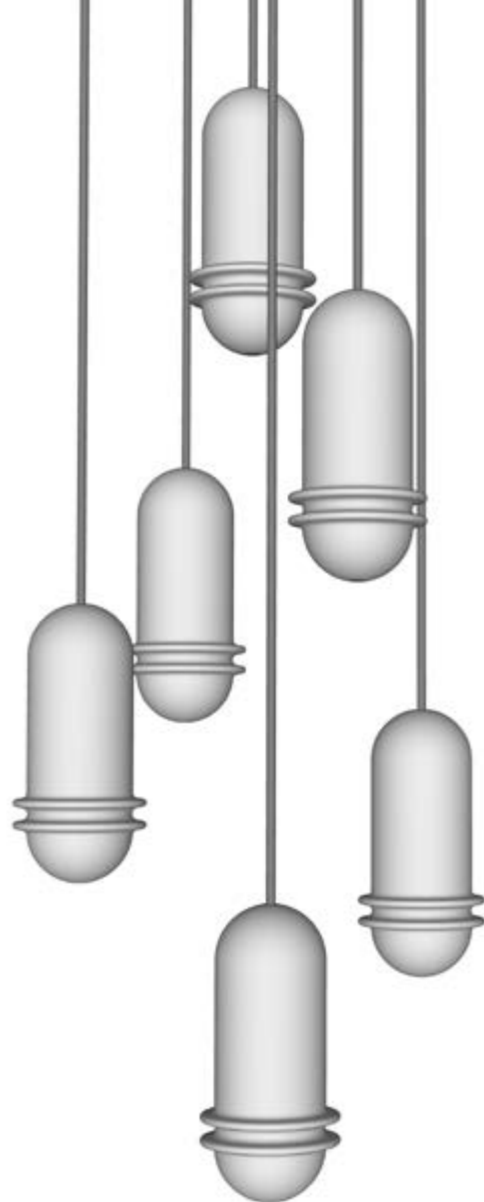

FROSTED HAND-BLOWN GLASS PENDANT.

One size only: h. 26,5 - ø 12,5 cm.

Additional inner light can be used with this model (see page 139).



HYDRA

VITAMINE METAL

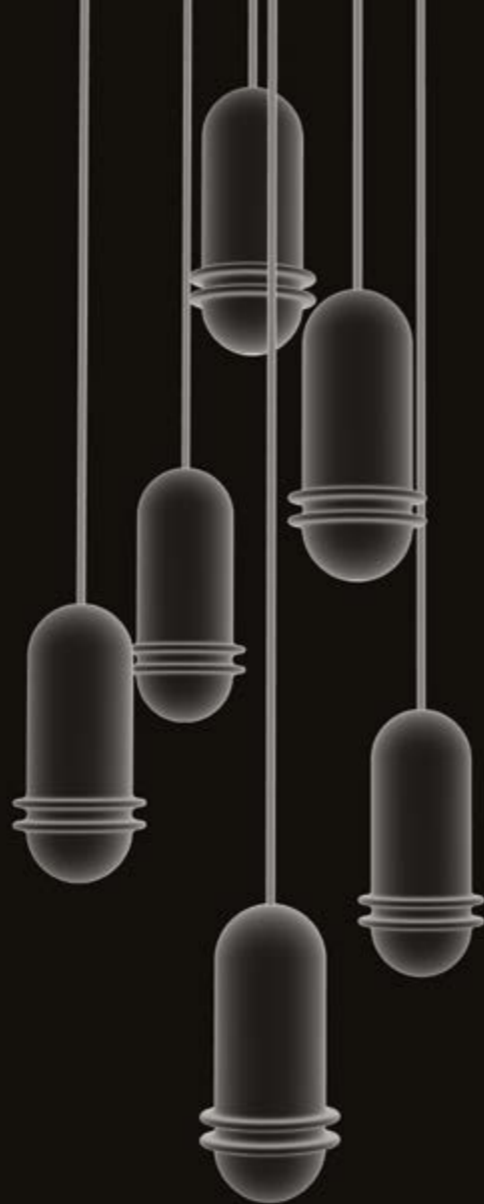

METALLIZED HAND-BLOWN GLASS PENDANT.

One size only: h. 26,5 - ø 12,5 cm.

Additional inner light can be used with this model (see page 139).



HYDRA SYSTEM

LED CEILING LIGHTS

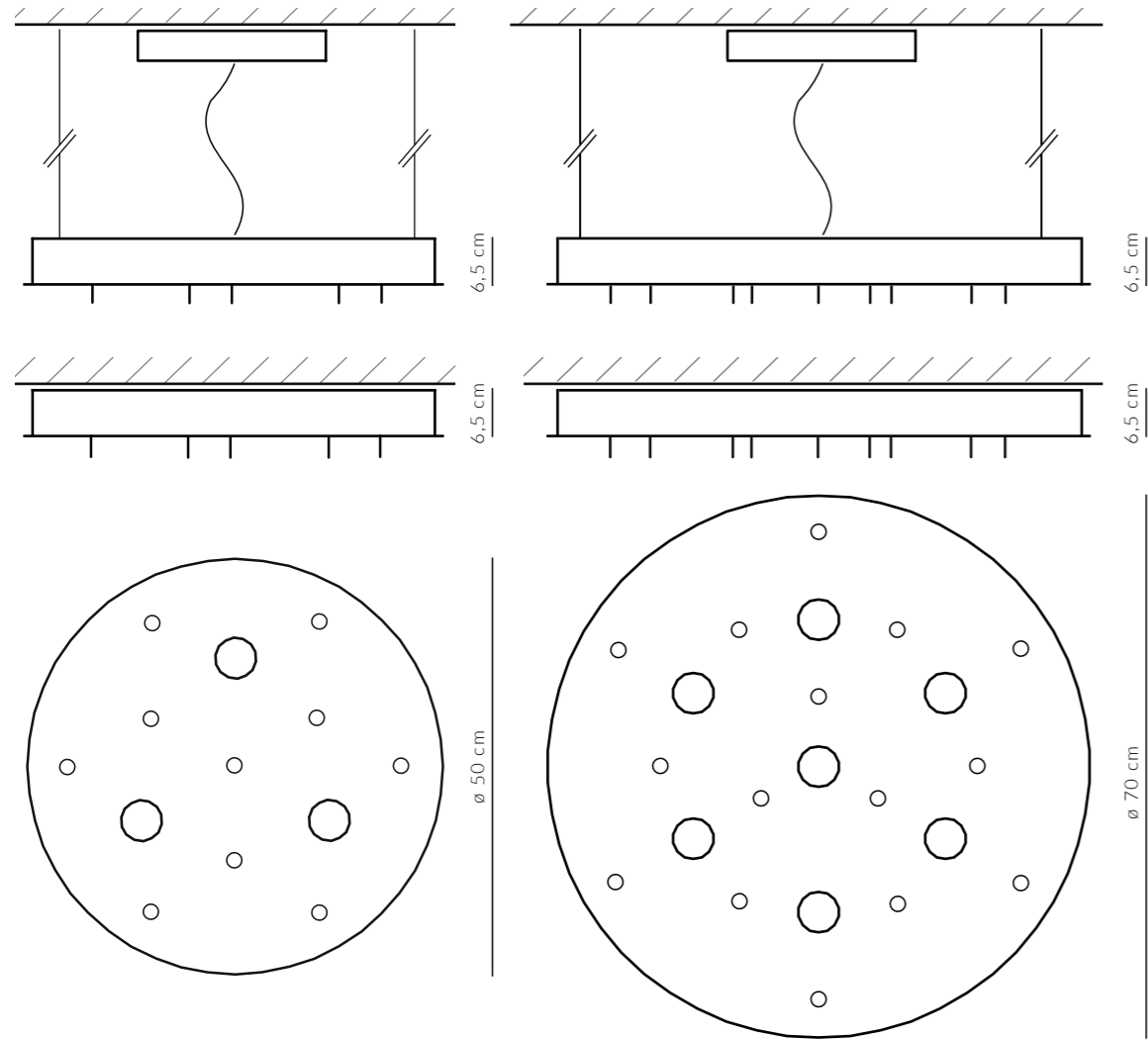

ROUND METAL CEILING.

SMALL_ø 50 cm. Varnished or mirror finishing.
3 x 10W power LED dimmable, 2700k optic 10°.
10 fixing supports for metallic mesh ropes.

LARGE_ø 70 cm. Varnished or mirror finishing.
7 x 10W power LED dimmable, 2700k optic 10°.
15 fixing supports for metallic mesh ropes.

melogranoblu can design and produce customized ceiling lights.





HYDRA SYSTEM

INNER LIGHTS

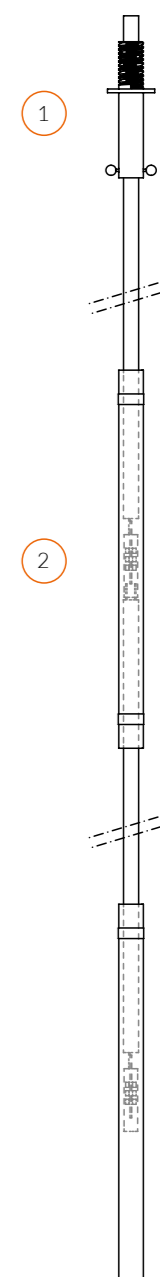

METALLIC MESH ROPE CAN BE ELECTRIFIED,
TO HAVE LIGHT INSIDE GLASSES.

- ① Special fixing support for false ceiling.
- ② Inner light for Hydra System glasses complete with special G4 pin LED bulb 2,5 W melogranoblu patent.

Additional inner light can be used only with following models:

Alpha, Berry metal, Beta, Datura, Delta, Diesis, Gamma ①, Stigma, Theta, Vitamine frosted, Vitamine metal.

CREDITS

COPYRIGHT

© 2017 by melogranoblu srl



CATALOGUE DESIGN

BABOL COMMUNICATION
www.babolcommunication.com

melogranoblu

Via Boschetti, 87

24050 Grassobbio

Bergamo _ Italy

Ph +39 035 4522451

Fax +39 035 19961841

sales@melogranoblu.com

www.melogranoblu.com

